

Linear actuator

Magforce STG

Benefits

- Modular
- Robust
- Reliable
- High speed and/or high load
- All metal design



Dimensional drawing

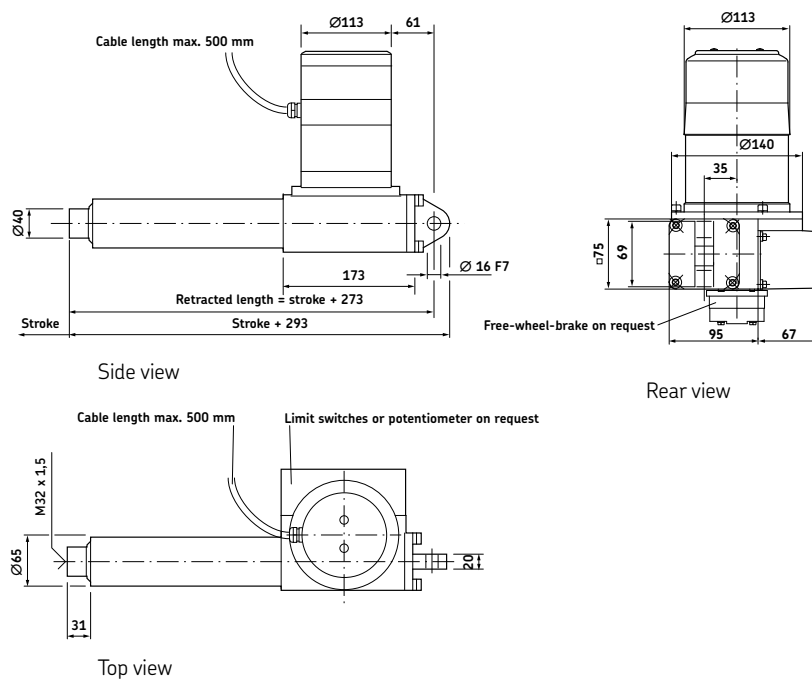

Connecting diagrams

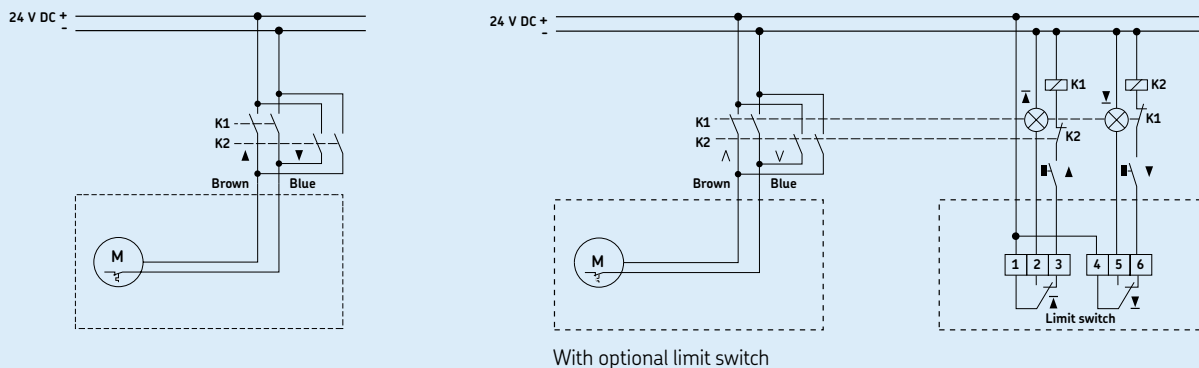

Technical data

	Unit	STG 10007	STG 12010	STG 15020	STG 15040
Rated push load	N	10 000	12 000	15 000	15 000
Rated pull load	N	10 000	12 000	15 000	15 000
Speed (at full load)	mm/s	14	11	5	3
Stroke	mm	100 to 700	100 to 700	100 to 700	100 to 700
Retracted length	mm	S+273	S+273	S+273	S+273
Voltage	V DC	24	24	24	24
Power consumption	W	840	840	768	528
Current consumption	A	35	35	32	22
Duty cycle	%	10 (1/9)	10 (1/9)	10 (1/9)	10 (1/9)
Ambient temperature	°C	-10 to +40	-10 to +40	-10 to +40	-10 to +40
Type of protection	IP	54	54	54	54
Weight (at 200 mm stroke)	kg	14,6	14,6	14,6	14,6
Color	-	Silver	Silver	Silver	Silver

Performance diagram

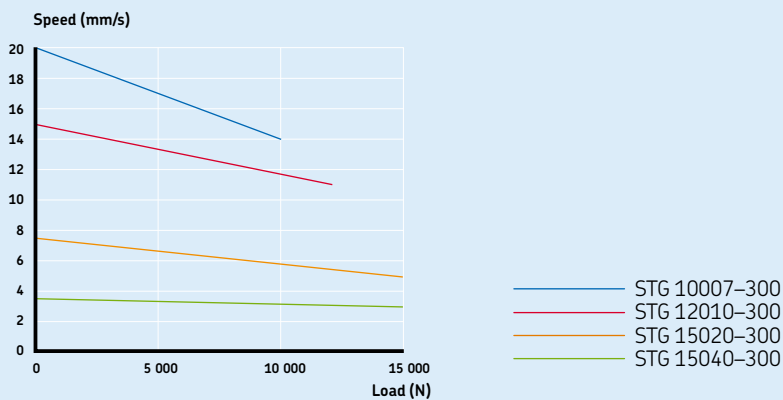

Speed-load diagram

Safety load factor conditions

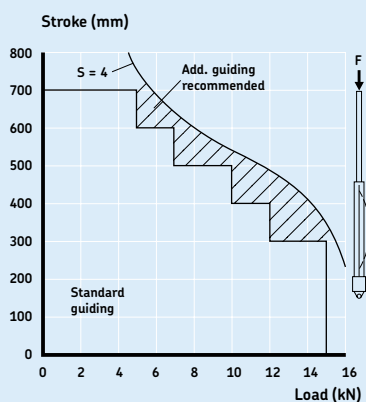

Bending of spindle $S =$ safety factor Euler 3

Options

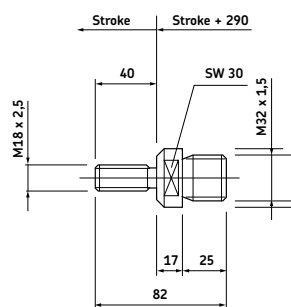

Adapter

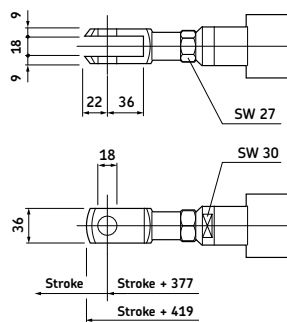

Fork head

Ordering key

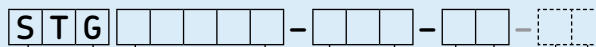

Type

Load:

10 000 N	10007
12 000 N	12010
15 000 N / 5 mm/s	15020
15 000 N / 3 mm/s	15040

Stroke (S):

100 mm	100
200 mm	200
300 mm	300
400 mm	400
500 mm	500
600 mm	600
700 mm	700

Option 1:

No option	01
<i>Others*</i>	<i>XX</i>

Option 2:

No option	O
Adapterbolt M18 1031,0106	E
Fork head (including adapterbolt) 1051,9038	F
Magnetic brake (1,4 Nm) 1031, 0219	G

Option 3:

No option	0
Limit switch	1
Potentiometer (1 000 Ω)	2
Encoder 1063,0020	3

Options shown in italics are only available on request.

Minimum quantities or additional costs apply for option 1 if shown in italics. For option 2 and 3 please contact your SKF representative.

Example for ordering an actuator without any options: STG10007-100-01.

Example for ordering an actuator with option fork head: STG10007-100-01-F0 (F0= with fork head).

**Example for others XX: Back up nut, extended motor shaft, low temperature grease...*

Spare parts

	Designation	Order N°
Adapter bolt	ZBE-1031,0106	M/0125265
Fork head	ZBE-1051,9038	M/0124705

