

Linear actuator

Magforce WSP

Benefits

- Modular
- Robust
- Reliable
- High speed and/or high load
- All metal design



Connecting diagram

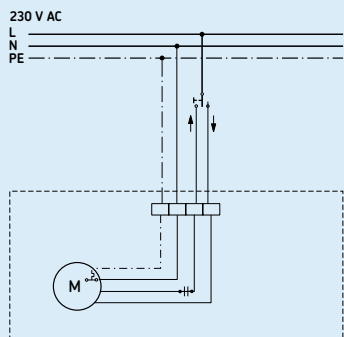

Dimensional drawing

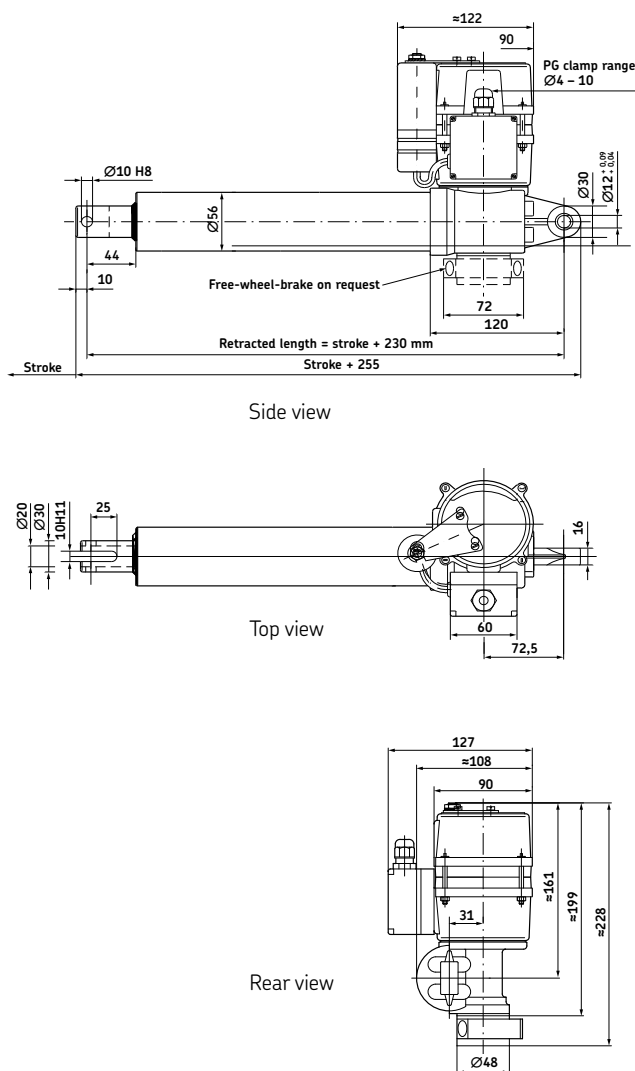

Technical data

	Unit	WSP 0510	WSP 1030	WSP 1550	WSP 2650
Push load	N	500	1 000	1 500 ¹⁾	2 600 ²⁾
Pull load	N	500	1 000	1 500	2 600
Speed (at full load)	mm/s	50	18	10	5
Stroke	mm	100 to 700	100 to 700	100 to 700	100 to 700
Retracted length	mm	S+230	S+230	S+230	S+230
Voltage	V AC	230	230	230	230
Power consumption	W	230	200	200	230
Current consumption	A	1,1	1	1	1,1
Duty cycle	%	25 (2,5/7,5)	25 (2,5/7,5)	25 (2,5/7,5)	25 (2,5/7,5)
Ambient temperature	°C	-10 to +40	-10 to +40	-10 to +40	-10 to +40
Type of protection	IP	54	54	54	54
Weight (at 200 mm stroke)	kg	5,5	5,5	5,5	5,5
Color	-	Silver	Silver	Silver	Silver

¹⁾Push load allowed up to 650 mm stroke (if S>650 mm, only pull load is allowed)

²⁾Push load allowed up to 500 mm stroke (if S>500 mm, only pull load is allowed)

Performance diagram

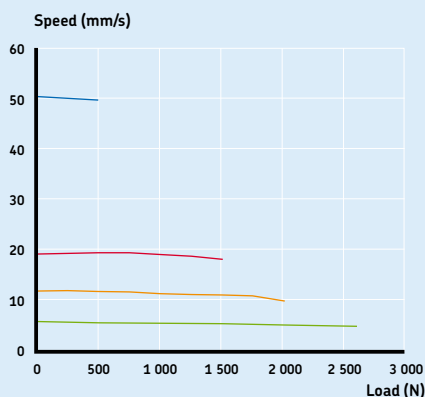

Speed-load diagram

- WSP 0510-200
- WSP 1030-200
- WSP 1550-200
- WSP 2650-200

Safety load factor conditions

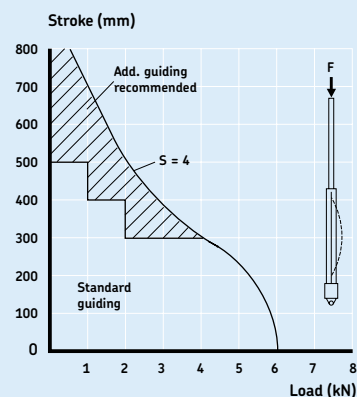

Bending of spindle
 $S = 4$ = safety factor Euler 3

Options

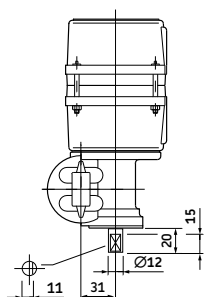

Extended motor shaft

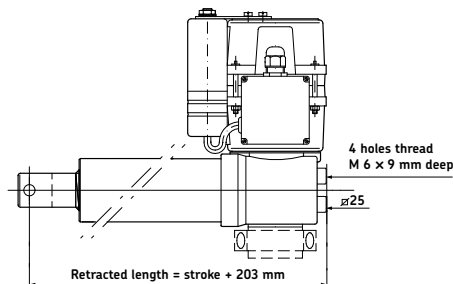

Rear screw fixing

Ordering key

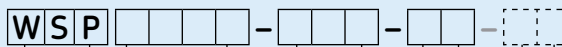

Type

Load:

500 N
1 000 N
1 500 N
2 600 N

0510
1030
1550
2650

Stroke (S):

100 mm
200 mm
300 mm
400 mm
500 mm
600 mm
700 mm

100
200
300
400
500
600
700

Option 1:

No option
*Others**

01
XX

Option 2:

No option
Free wheel brake on push load, 1028, 6228
Free wheel brake on pull load, 1028, 0002
Friction brake for pull/push load, 1028, 7851

0
A
B
C

Option 3:

No option
Limit switch

0
1

Options shown in italics are only available on request.

Minimum quantities or additional costs apply for option 1 if shown in italics. For option 2 and 3 please contact your SKF representative.

Example for ordering an actuator without any options: WSP1030-100-01.

Example for ordering an actuator with option limit switch: WSP1030-100-01-01 (01= with limit switch).

* Example for others XX: Add. guiding bush - $L=S+280$ mm, protection tube made out of stainless steel, bronze nut, low temp grease -30° , extended motorshaft, rear attachment hole turned 90° , without rear attachment; motor turned 90° .

Spare parts

Description	Designation	Order N°
Limit switch 100 mm stroke	1043,0209-100	M/0126964
Limit switch 200 mm stroke	1043,0209-200	M/0126965
Limit switch 300 mm stroke	1043,0209-300	M/0126966
Limit switch 400 mm stroke	1043,0209-400	M/0126967
Limit switch 500 mm stroke	1043,0209-500	M/0126968
Limit switch 600 mm stroke	1043,0209-600	M/0126969

